

ALUMINIUM SECTIONS

**KAS6101**  
Short Equal Leg  
Outer Frame

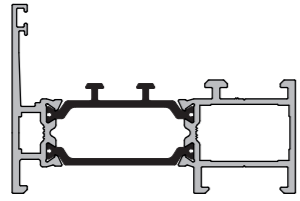

**KAS6102**  
Odd Leg Outer Frame  
(Bead Out)

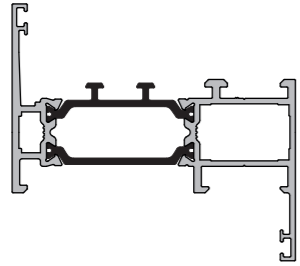

**KAS6103**  
Long Equal Leg Outer Frame

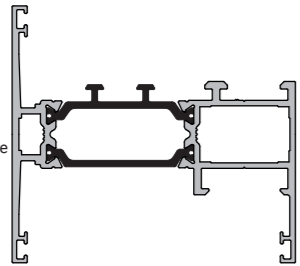

**KAS6104**  
Odd Leg Outer Frame  
(Bead In)

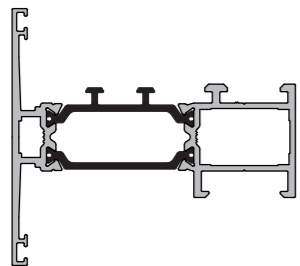

**KAS6105**  
Mullion / Transom

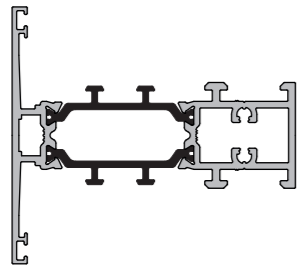

**KAS6106**  
Wide Mullion / Transom

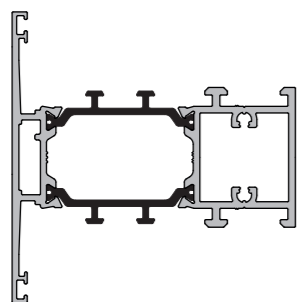

**KAS6107**  
Casement Vent Adapter

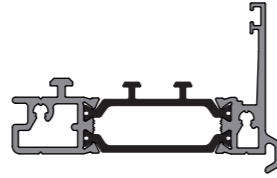

**KAS6108**  
Tilt Before Turn Vent

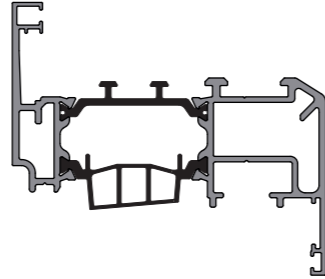

**KAS6109**  
Casement Vent

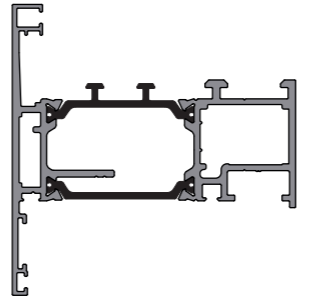

**KAS6111**  
Flush Coupler  
(And Head Extension)



**KAS6112**  
75mm Corner Post

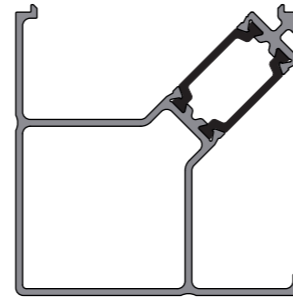

**KAS6113**  
Expansion Coupler

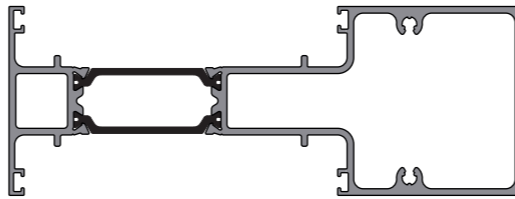

BEADS

**KAS6131**  
24mm Square

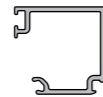

**KAS6132**  
28mm Square

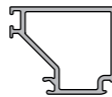

**KAS6133**  
32mm Square

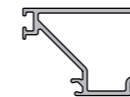

CILLS

**KAS621**  
Cill Base



**KAS625**  
180mm Cill Nose

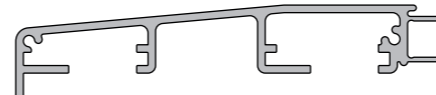

**KAS623**  
110mm Cill Nose

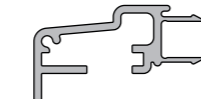

**KAS626**  
205mm Cill Nose



**KAS624**  
155mm Cill Nose

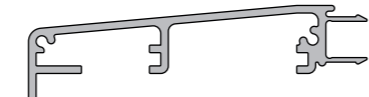

**KAS627**  
250mm Cill Nose

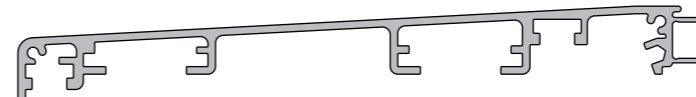

PVC SECTIONS

**KAS291**  
Friction Hinge  
Locator Profile



**KAS742**  
Channel Filler



**KAS290**  
Hinge Packer - 17 Cav



**KAS628**  
Curtain Wall Adapter

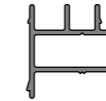

**KAS2863-R**  
Thermal Profile  
Vent Side



THERMAL INSERTS

**KAS255-TI-1**  
42mm x 5mm - IGU



**KAS255-TI-2**  
25mm x 12mm - Frame



**KAS255-TI-3**  
13mm x 21mm - Vent

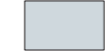

**KAS255-TI-4**  
46mm x 10mm - Perimeter



**KAS255-TI-5**  
46mm x 26mm -  
Perimeter Long Leg



**KAS255-TI-6**  
50mm x 10mm - Perimeter  
(Non Combustable)



**KAS255-TI-1**  
50mm x 26mm -  
Perimeter Long Leg  
(Non Combustable)



GASKETS

**KAS2860**  
Rebate Gasket



**KAS2861**  
Retaining Gasket 3.5mm



**KAS2862**  
6-8mm Wedge Gasket



**KAS282**  
Retaining Gasket



**KAS477**  
4mm Wedge Gasket



**KAS2864**  
Thermal Gasket -  
Frame Side



**KAS2865**  
Centre Seal -  
Open In

